



# The Legend of Lorelei

Volume 51, Issue 2

March/April 2022

## Lake Safety Patrol Volunteers

are needed to be able to continue this program through 2022. It is a great way to help the community both on and off the water.

If you are interested, please contact Chris Kwiatkowski at [Director@Lakeloreleiohio.com](mailto:Director@Lakeloreleiohio.com) for details.

**Commitment level and schedule are completely up to you!**



### Calendar

#### March

|    |                              |         |           |
|----|------------------------------|---------|-----------|
| 10 | Activities Committee Meeting | 7:00 PM | Clubhouse |
| 18 | Friday Night Hangout         | 6:30 PM | Clubhouse |

#### April

|    |   |              |           |
|----|---|--------------|-----------|
| 1  | Friday Night Hangout                    | 6:30 PM      | Clubhouse |
| 5  | Tuesday Fishing Tournament              | 6:00-8:30 PM | Marina    |
| 6  | Arts & Crafts Club                      | 6:30 PM      | Clubhouse |
| 7  | Women's Club Meeting                    | 7:00 PM      | Clubhouse |
| 14 | Activities Committee Meeting            | 7:00 PM      | Clubhouse |
| 15 | Friday Night Hangout                    | 6:30 PM      | Clubhouse |
| 19 | Tuesday Fishing Tournament              | 6:00-9:00 PM | Marina    |
| 29 | Spring Yard Sale - Members only, 6-8 pm |              |           |
| 30 | Spring Community Yard Sale, 9 am - 4 pm |              |           |



#### May

|   |   |              |           |
|---|---|--------------|-----------|
| 1 | Spring Community Yard Sale, 9 am - 4 pm |              |           |
| 3 | Tuesday Fishing Tournament              | 6:00-9:00 PM | Marina    |
| 4 | Arts & Crafts Club                      | 6:30 PM      | Clubhouse |
| 5 | Women's Club Meeting                    | 7:00 PM      | Clubhouse |

**Next Issue Adv/Copy Due: April 20, 2022**

## Finance Committee - Dredging Information

Todd Steinbrink, Chair

As the Lakes Fund assessment begins to accumulate, there have been many questions about how members can help do more to reduce the cost of the upcoming dredging project. Here's the great news, we have two options!

### Lakes Fund Assessment Prepayment Plan

For those interested in helping the association save a portion of the borrowing costs associated with the dredging effort, members and the Board have discussed and approved a plan to allow members to "prepay" a portion of their Lakes Fund assessment. Regular payments are \$150 on each six-month billing period, but if interested, members may pay their assessment "up-front" for a period of years. There is no required period, but for example, if you wished to prepay 5 years (\$1,500) or 10 years (\$3,000), contact the office who will complete and register that amount on your account. If you elect to pre-pay, no Lakes Fund assessment will appear on your regular billing for the period you selected. If all your property is sold and you are no longer a member prior to the next Lakes Fund Assessment due date, the Buyer/Title Company will add the remaining amount, per the agreement you signed, as an additional amount owed to the Seller on the HUD closing statement. The result of this action will mean the new buyer will not owe any lakes fund assessment for the property until the "next due date". The benefit of this program to the association is that with more money collected up front, less will need to be borrowed, thereby saving interest expense. It's a great way to help the Association accomplish dredging more cost effectively!

### Greater Lake Lorelei Water Improvement Corporation

A second group of dedicated individuals around the lake has been working hard for years to help support and fund water quality initiatives to benefit the water that flows into, through and out of our lake. GGLWIC as its known, is a 501(c)3 organization that has created a "Jumpstart" program to raise dollars for the Lake Lorelei dredging effort. By charter, GLLWIC is able to match any spending dedicated to water quality initiatives in or around Lake Lorelei. Since the Association is on track to spend a substantial amount of money on the lake, the Association can apply for matching grants from GGLWIC. Your tax-deductible donation can be expressly dedicated to the dredging effort.

The benefits are:

- Tax deductible gift (consult your tax preparer)
- Additional source of funds for lake dredging
- Any amount of matching grant funds received will lower the overall cost of the dredging project to the members

Please note that any amount donated to GGLWIC is **NOT** considered payment of your Lakes Fund assessment.

The Lakes Fund Committees have been working hard and the dredging effort is closer to a reality than ever! If you are interested in either of these financial alternatives, the Board and entire membership welcome your support.

*Editor's note: Please see additional articles and information throughout this issue. ✂*



**Contact the entire Board of Trustees with one email address:  
board.trustees@lakeloreleiohio.com**

# Lake Lorelei



Buyers are constantly calling me but the inventory is extremely low.  
If you are thinking about selling please give me a call.

*Thank you for your continued support!*



**PENDING**

299 Bremen Drive



**PENDING**

508 Munich Drive



**ACTIVE**

800 Bonn Drive



**ACTIVE**

311 Bremen Drive



**FULL-TIME LAKE RESIDENT WITH OVER  
115 LAKE LORELEI TRANSACTIONS**

**Marcia Greenwald**  
AT HOME WITH DIVERSITY CERTIFICATION, SRS  
EXECUTIVE SALES VICE PRESIDENT

(513) 503-1573  
mgreenwald@sibcyclyne.com  
www.sibcyclyne.com/mgreenwald



This is not intended to be a form of solicitation if you are working with another broker.

# Activities Committee - Upcoming Events



**OR**



## Clubhouse HANGOUTS

On the **FIRST & THIRD FRIDAY** of each month

**March 4th and 18th**  
**April 1st and 15th**



**We NEED YOU**  
to help plan all of our  
**FUN EVENTS!**

Please come to a  
meeting - 2nd Tuesday  
of the month at 7 PM in  
the Clubhouse.

dickymo4@cinci.rr.com

Coming this summer!  
Poker Boat Runs  
Music  
& MUCH MORE!!!



*Look for more Activities Info on the front board and  
on Facebook*



### LOW-Impact AEROBICS

at the Clubhouse

Mondays, Wednesdays  
and Fridays

**9:30 am**

## Women's Club Report

Deborah Osborne, Secretary



Since our last report, the Women's Club completed our annual project of assembling 20 back packs for the Brown County Family Services. These back packs are given to children entering foster care, and each one included a blanket, stuffed animal, books, crayons and pencils, a hat and a toothbrush/toothpaste. Thanks to Jenny Borton, Marion McCoach, Barb Siegel, Martha Wallace and Amy Wohleber for putting the packs together, to Barb Ogden for donation of the back packs, and to the many others who contributed to their contents.

The Women's Club did not meet in January or February. Our March meeting will include a presentation by a representative from a local business - **Honey Sweetie Acres** (the goat farm!). The April meeting will include a presentation on homemade jewelry from one of our own members - **JOENNE HERDMAN**.

Upcoming projects/events:

April 1, 2022 (Friday) - the WC will meet at Hope Emergency at 10am to put together Easter baskets that will be given out by Hope to families for Easter. **Ladies - bring bags of individually wrapped candies to the March meeting to be included in these baskets!**

April 29 - May 1 - Lake Lorelei Community Yard Sale

We meet in the Clubhouse on the First Thursday of each month at 7 PM. Join us! 🍷



Custom Building and Remodeling  
Kitchens • Baths  
Decks • Room Additions  
[www.stirncontracting.com](http://www.stirncontracting.com)

## Your Lake Lorelei Neighborhood Contractor

Visit us at [facebook.com/stirncontracting](https://facebook.com/stirncontracting)



Specializing in kitchen and bath remodels, additions, decks and docks. Call us today for a quote on your next project!

**Eric Stirnkorb 513-646-3909**

**Rick Stirnkorb 513-497-3659**

**Visit our web page or Facebook page for a gallery of our work.**

# Lakes Fund Update

Scott Kaufman, Communications Chair

With the passing of the Lakes Fund earlier this summer, the Board of Trustees created a new Lakes Fund Committee. The purpose of this committee (comprised of current Lake Lorelei property owners) is primarily to develop strategies for programs, projects and procedures for the protection, preservation, and enhancement of all LL lakes. The Lakes Fund Committee's areas of concern include Shoreline Maintenance, Water Quality Testing, Lakes Treatment Programs, Dredging Program, Lake Safety, and Lake Valves, Dam, & Spillway Maintenance that will ultimately serve as recommendations to the Lake Lorelei Board of Trustees. Currently, the main focus of the Lakes Fund Committee is dredging.

## **"Pay it Forward" Program:**

To help Lake Lorelei move forward with the dredging project in a timely manner, the Lakes Fund Committee is seeking residents who are willing to **pre-pay their Lakes Fund Assessment** for a number of years (ideally ten or more). These prepaid funds will reduce the amount of money we need to initially borrow, thus allowing the fund to grow faster and reduce the overall interest costs associated with the dredging project. Our bylaws prevent us from being able to offer any type of 'discount' for advanced payments, but our community would greatly benefit from and appreciate the head start.

Please see the "Pay it Forward" information letter in this Lorelei Legend Issue and feel free to e-mail questions to our Communications E-Mail Account: [LLOhioLakesFund@gmail.com](mailto:LLOhioLakesFund@gmail.com)

## **Dredging Committee Update:**

- ◆ The Dredging Committee continues to interview and tour potential dredging companies in preparation for their bid submittal. Through these interviews, past dredging investigations, and company tours, the Lead Team, spear-headed by the dredging committee, was able to complete the final version of the RFP (Request for Proposal).
- ◆ The RFP developed by the Dredging Committee has been approved unanimously by the Board of Trustees and signed by the Board President in February.
- ◆ The RFP has been sent to ten (10) potential bidders with a return date required in March.
- ◆ Bids will be delivered to the office in sealed envelopes and opened only by the Lake Fund Lead Team.
- ◆ The overall master plan that was approved by the Board of Trustees calls for the month of April to develop a matrix to compare bids against each other.
- ◆ The Lakes Fund Team will have the task to recommend to the Board if the bids are sufficient to move forward, or if another round of bids might be necessary. Quality of work, overall cost, interviews with the dredgers' references as provided, and dredging experience are all factors to determine a successful bid.

## **Finance Update:**

The Finance Committee continues to interview financial institutions. As we all are aware, the economic conditions over the past few months continue to present some unexpected challenges. Interest rates are rising and the uncertainty in the markets has made financial commitments from institutions more difficult. The Committee work continues to investigate and interview financial institutions who have experience in projects like ours. Progress has been made and the Committee is evaluating options available. Once all options have been explored, a recommendation will be made to the Board of Trustees for approval.

Spring is around the corner and the water is on the rise!! 🍷

**Our "Secret Paradise" has been discovered!**  
**I have Buyers in all price ranges contacting me daily!**  
With over 30 years of experience, I have the knowledge and compassion to help buyers and sellers make the right home ownership and investment decisions. As an owner of waterfront property since 2002, I have a strong interest in the values and conditions of our community as well.  
If I can assist you, please call me.



862 LORELEI DR



799 BONN (LOT) - \$5,500



1371 RUHR DR (LOT) - \$8,000

*"Chris is an amazing Realtor! She helped us sell and buy a house. We hadn't bought a house in 17 years and we had no idea what had changed in real estate. She walked us through every step and always made herself available, day and night! We are so very grateful she was our Realtor."*  
- Jamie & Eric 2022

*the best  
memories  
are made at the  
lake*

I have ready, willing, able, and qualified buyers looking for waterfront AND off water homes. If you are thinking of selling, please contact me ASAP!



**Chris Behm**  
**Comey & Shepherd, REALTORS®**  
**(513) 518-2353**  
**chrisbehm1@gmail.com**



**Experience counts! 184 transactions just at Lake Lorelei!**

# Fish Committee - 2022 Schedule

Tom Iles, Chair

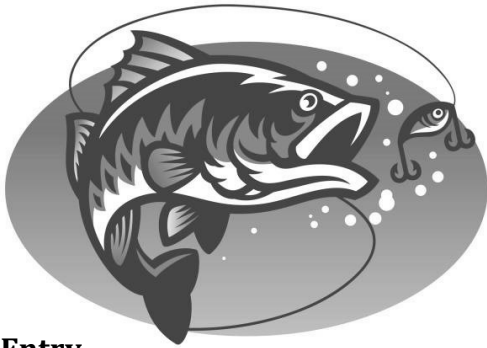

## Dates

|                       |                        |
|-----------------------|------------------------|
| April 5th 6-8:30 P.M. | July 5th 6-9:30 P.M.   |
| April 19th 6-9 P.M.   | July 19th 6-9:30 P.M.  |
| May 3rd 6-9 P.M.      | Aug. 2nd 6-9:30 P.M.   |
| May 17th 6-9:30 P.M.  | Aug. 16th 6-9 P.M.     |
| June 7th 6-9:30 P.M.  | Sept. 6th 6-9 P.M.     |
| June 21st 6-9:30 P.M. | Sept. 20th 6-8:30 P.M. |

## Entry

Entry Fee: \$20.00 Per Team

Individual Fee: \$15.00

\$5.00 Of Entry Will Go Toward Big Bass

## Prizes (number of boats competing)

5 Boats Or Less: 1st Place 100%

6-8 Boats 2 Places: 70% & 30%

9 Boats And Up 3 Places: 50%-30%-20%

**Spring Tournament - April 16th; 7am - 3pm**

**Kids Tournament - June 25th; 5:30pm - 8pm**

**Night Tournament - August 20th; 12am - 8am**

**Fall Tournament - October 8th; 7:30am - 3:30pm**

## Tuesday Evening Rules

- ◆ Ties Will Be Resolved In The Following Order:
  - ◇ Largest Number Of Fish, Largest Fish And A Flip Of A Coin
- ◆ A Limit Of 5 Bass Per Person At Least 12 Inches Long, Measured With The Mouth Fully Closed
  - ◇ 10 Bass Per Boat
- ◆ Official Time Will Be Kept. One Person Must Be At The Marina And On The Ground At Official Quitting Time.
- ◆ All Fish must be brought to the scales in a weigh-in bag with sufficient water.
- ◆ All Boats Must Return To The Check-In Site For The Weigh-In.
  - ◇ Teams Or Individuals That Are Late For The Weigh-In Will Be Penalized 1 Pound Per Minute Up To Ten Minutes, Then Disqualified.
- ◆ No Dead Fish Will Be Weighed In.
- ◆ All Property Owners Must Have **2022-23** Stickers On Their Boats.
- ◆ We Understand And Agree That The Lake Lorelei Property Owners Association, Inc., Its Members, Trustees, And Other Participants Are Hereby Waived Of Any Responsibility For Damages, Injury, Or Loss Incurred During This Tournament.
- ◆ No Live Bait Is Allowed.
- ◆ **Be At The Marina at 5:30!!!**

## Angler Of The Year Point System

- ◆ Points Will Be Awarded To Individuals for each night of fishing.
- ◆ The End Of The Year Prize Will Be \$100.00 (One Hundred Dollars) Cash And Two Plaques. Paid For By The Fish Committee.
- ◆ Points Will Awarded As Follows:
  - ◇ 5 Points First Place,
  - ◇ 4 Points Second Place,
  - ◇ 3 Points Third Place,
  - ◇ 2 Points For Big Bass. Big Bass Will Be Awarded To Both Individuals No Matter Who Caught The Fish.
  - ◇ 1 Point Will Be Given For Showing Up If You Do Not Place.



Advertisement

## **WE ARE STILL LOOKING FOR A FEW GOOD LORELEI'EES TO DONATE TO *JUMPSTART***

### **THE LAKE LORELEI DREDGING PROJECT IS PICKING UP "STREAM"!**



The lake dredging project is moving through the planning and preparation process as we move ever closer to the first scoop of "Muck" being removed from our Lakes. We all are aware that the assessment was passed, and the funds are starting to "flow" in, but GLLWIC and its Donors want to help expedite the process to improve the water quality of "Our Lakes".

### **GLLWIC NEEDS YOUR HELP TO DO THIS!**

The "JUMPSTART" fundraising campaign is off to a great start, and we are close to 40% of our goal of collecting 100K to provide assistance to key aspects of the dredging project.

GLLWIC (Greater Lake Lorelei Water Improvement Corp.) is a 501c3 Non-Profit. Your donation could be "TAX DEDUCTIBLE", so why don't you join us and become part of the "JUMPSTART" team and donate today! We are looking for 63 LORELEI'EES—Friends, Family Members, or Businesses to each Donate \$1,000 to help us reach our GOAL.

Your JUMPSTART donation will be held in a specific "dredging fund" and accessed through the GLLWIC Funding Guidelines. As funds become available, GLLWIC will establish grants for specific projects outlined by the Dredging Committee, and requested by the Board of Trustees. Your donation does not replace your assessment fee; it helps your fees go to work sooner. 100% of your donation will be restricted for the dredging project and will add flexibility and options for the dredging teams.

**Please consider a gift TODAY! All Gifts are Greatly Appreciated.**

For more information:

[GLLWIC http://lakeloreleiwater.org/charitable-donations](http://lakeloreleiwater.org/charitable-donations)

Checks should be made payable to **GLLWIC**:

Send to Margaret Gaither, GLLWIC Secretary, 553 Kleist, Fayetteville, OH 45118

# John's Flowers

**Spring is officially here!!  
Come see us for your planting needs**



**2022 Proven Winners!**  
Large assortment of Annuals & Perennials  
Trees ~ Shrubs ~ Bedding  
Mulch (Bulk & Bagged) ~ Top Soil  
Delivery Available

**Nursery & Greenhouse  
513-875-3400**

Located on Howard Road ~ 1 mile south of Fayetteville  
off RT 68

**Monday-Saturday 9AM-7PM Sunday 10AM-4PM**

# Fisherman's Wharf

**At Lake Lorelei  
513-875-3332**



**Owner/Operators  
Barb and Bob Kiley  
LLPOA Members since 1970**

Ohio Lottery and Instant Tickets

Bait ~ Ice ~ Beer ~ Gas

ATM



# Letter to All Members

## Lake Lorelei Dredging Project “Pay it Forward”

February 2022

Dear LLPOA Members,

Last Summer, we came together as a community and approved a Lakes Fund Assessment of \$300 per year, per member. These funds will provide the resources necessary for our Lakes Fund Committee to begin the much needed work to preserve the quality of all of our three lakes.

To help us move forward with the dredging project in a timely manner, the Lakes Fund Committee is seeking residents who are willing to **pre-pay their Lakes Fund Assessment** for a number of years (ideally ten or more). These prepaid funds will reduce the amount of money we need to initially borrow, thus allowing the fund to grow faster and reduce the overall interest costs associated with the dredging project. Our bylaws prevent us from being able to offer any type of ‘discount’ for advanced payments, but our community would greatly benefit from and appreciate the head start.

Here is how the pre-payment works:

- The agreement on the following page will be given to the member to complete and submit the “Proof of Pre-Payment of their Lakes Fund Assessment” Form.
- It is the responsibility of the member to file this form and the pre-payment with the Lake Director.
- Both signatures are required to show the exchange of funds to be accurate.
- The original should remain with the Member and a copy will be filed in the office.
- In the case of a property sale, it is the member’s (seller’s) responsibility to alert the buyer and their realtor to this agreement, once they have plans to sell their last property, *Thus, you are soon not to be a member of the LLPOA.*
- The LLPOA office will work with the Title Company, upon the Title Company’s request for the HUD statement information, to confirm the amount of credit due to the Seller from the Buyer.

We appreciate your consideration of the Lakes Fund Assessment pre-payment option.

Thank you,

The Lakes Fund Committee

## **Lake Lorelei POA Pre-Pay Lakes Fund Notice**

I agree to pre-pay the Lakes Fund Assessment in the amount of \_\_\_\_\_  
which equates to \_\_\_\_\_ years. As a result, the next Lakes Fund Assessment for  
the Property with a primary address of  
\_\_\_\_\_  
will be due on \_\_\_\_\_ (“next due date”).

I have the original copy of this notice and a copy will be kept in a file under my  
POA association membership. If all my property is sold and I’m no longer a  
member, prior to the next Lakes Fund Assessment due date, the Buyer/Title  
Company will add the remaining amount per this notice as an additional  
amount owed to the Seller on the closing statement (HUD Statement). The  
result of this action will mean that the new buyer will not owe any lakes fund  
assessment for the property until the “next due date”.

By LLPOA Member: \_\_\_\_\_ (Signature) \_\_\_\_\_ (Date)

Name: \_\_\_\_\_ (Print Name)

By Lake Director: \_\_\_\_\_ (Signature) \_\_\_\_\_ (Date)

Name: \_\_\_\_\_ (Print Name)





**The Lawn Care and Landscaping Professionals**  
Residential and Commercial properties

***Total Lawn Maintenance ~ New Lawns/Repairs  
Full Service Landscaping  
Hardscapes/Retaining Walls  
Outdoor Paver Patios/Walkways ~ Water Features  
Stone Works ~ Shore Repair ~ Beaches  
Seasonal Lawn/Bed Maintenance  
Fence Install-Vinyl/Split-Rail***

Competitive Rates ~ Fully Insured ~ Free Estimates

Call **Josh** to schedule your free estimate **today!**

**(513) 305-5296**

Visit Us Online **[www.walkerlandscapeandlawncare.com](http://www.walkerlandscapeandlawncare.com)**

Or email **[WLLC@twc.com](mailto:WLLC@twc.com)**

***Mention you found us in The Legend of Lorelei for \$\$ OFF Savings for New Customers***

# PRIDE Committee Updates

Len Pohlar, Chair

**PRIDE = People** Representing Initiative, Dedication and Energy

**ARE YOU READY FOR SPRING??** I know I am and that means that the PRIDE Committee will be back outside working to make Lake Lorelei the best place to live anywhere around. VOLUNTEERS are what makes PRIDE work so well and we hope that YOU will take some time out of your days this year to join our efforts and meet your neighbors along the way. We maintain an email list of volunteers to communicate details of specific projects in real time as well as posts on our local Facebook group pages and here in the "Legend of Lorelei". **Please consider joining our email group** by sending an email to [pride@lakelorelei.ohio.com](mailto:pride@lakelorelei.ohio.com). You will stay informed about our work and can contribute your ideas in a very effective manner. We are always looking for those willing to step up to become directors and area leaders within PRIDE. Our directors ensure that PRIDE is properly engaged with LLPOA trustees, office and members, while our area leaders maintain vigilance on their assigned areas to bring fresh ideas properly documented in our PRIDE Master Plan.

PRIDE is planning to return to a popular activity from years past known as the **Beautification & BBQ (B&B)**. The dates are still a bit fluid but we envision a Saturday morning in early-to-middle May, starting mid-morning around 9 am, and providing a lunch for all those who attend. The exact details will be advertised to our volunteers, the Lake Facebook pages, to other Lake Lorelei Committees and clubs, as well as in the next "Legend of Lorelei". Bring your whole family to make Lake Lorelei shine for the next season of fun with family and friends.



VOTE  
For

Wayne W. Lowery

- Full Time Resident since 2013
- Constitutional Conservative
- Represent the best interests of Lake Lorelei with the County Republican Party

Brown County Republican Party Central Committee  
Representing Precinct 201 (Lake Lorelei)  
Primary Election May 3, 2022

Precinct Location:

FAYETTEVILLE MIDDLE SCHOOL  
601 APPLE ST  
FAYETTEVILLE, OH 45118



POLITICAL AD PAID FOR BY THE CANDIDATE

**Fundraisers:**

**Calendars:** PRIDE is funded mainly through donations to the PRIDE Calendar which you should all have received recently in the mail. We thank you for those donations now and any you provide throughout the year.



**Mailboxes:** We also build and install very sturdy and attractive mailboxes that are visible around the lake. We are now taking orders for our spring production build. We have two configurations that we offer as shown in the photos here. Our standard configuration is \$250 and the alternative configuration is \$260 since we provide two number plates instead of one. This mailbox is fully installed in concrete, in accordance with all USPS requirements. Send your request to [pride@lakelorelei.ohio.com](mailto:pride@lakelorelei.ohio.com) and we will promptly get back to you to confirm your selection, as well as validating which mailbox you wish to remove or install new.



In 2022, PRIDE will continue to look at improvements to our entrance “curb appeal”, improvements to the beach, clubhouse and play areas to benefit all members, including potential projects to enhance accessibility. Do you have any ideas you would like Lake Lorelei to address that falls within the scope of a PRIDE project? Let us know at our email address listed above.

**ONE PERSON can make a difference.** That person can be **YOU!** Take the initiative – Join our email group! ☺

# Tom Kuebler

## Carpets & Upholstery Cleaning

25 years experience



**Deep Steaming  
Truck-mounted equipment**

**Living room & Dining room & Hall \$45  
Any Five areas \$75  
Sofas \$45 · Loveseat \$35 · Chair \$25**



**Now offering carpet and upholstery cleaning for  
RV's · Motor Homes · Campers · Car Interiors**

**Call 513-444-4146**

**“I clean each carpet like it is my own”  
All work guaranteed**

# Meet the Candidates!

## Cindy Tullis

Hi! I am Cindy Tullis and reside at 116 Munster Drive with my husband Scott Tullis. We have been here at the Lake since 2015, starting off as weekenders and transitioning into full time lake residents in 2021. It was the best decision we ever made!



The environment here at Lake Lorelei is so welcoming and fun! Maintaining our culture and preparing us for the best future possible is the reason I'm interested in running for the Board of Trustees. A little about me: I work for a Market Research Firm as a Senior Vice President. I enjoy digging into problems and coordinating teams to collaborate toward a common purpose to accomplish our goals.

### Here is where I stand on key topics:

1. Communication/Transparency – I'm a straight shooter and believe in the community being aware of all issues being dealt with and board transparency. As a Market Researcher by trade, I'm happy to apply my professional skills to further understand the needs of our community.
2. Security – The lake is a safe place to live, but there is always room for improvement. The perimeter fence is in big need of repair and should be a priority, as well as some general safety measures, like placing cameras around the perimeter. These repairs all cost money, so we would need to resolve how we prioritize issues and allocate necessary funding.
3. Finance – In order to achieve all our goals, we need to find ways for the Lake to generate revenue. Some things to consider include utilizing some of the lake lots for watercraft/mobile home storage (can also be offered to others outside the community); have more community functions (like 4<sup>th</sup> of July) where we have festivals to generate income; and consider Bingo or Monte Carlo nights including others outside the lake.
4. Water Quality – The lake is our biggest asset and needs to be cared for to prevent poor water quality. I'm open to exploring all options to maintain this and working with groups trying to find the best ways to keep our water clean. I have been involved in the dredging efforts and have been volunteering on the Lakes Fund Committee in the Communication group.
5. Fun – I want to work with the committees to keep the fun coming and continue to bring the lake together!

### Why should you vote for me?

- a. I'm a strong leader and believe collaboration is the key to success.
- b. My profession is gathering customer insights and making recommendations for driving business. I would utilize these skills in understanding our community needs and finding solutions.
- c. This community has become like family to us. I want to see it grow and thrive.
- d. P.S. I'm the biggest Ohio State fan you will ever meet!

## Board of Trustees Election Schedule

Applications Due in Office by March 15

Ballots Postmarked by May 4

Ballots Mailed by April 20

Ballots counted by week of May 16

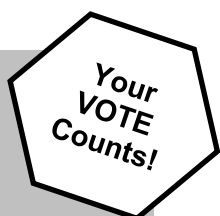



## Todd Steinbrink

This summer will mark our 11<sup>th</sup> season at the lake, but our clan has grown with five more members since we first arrived. "The lake" has become a big part of the foundation of our family.

At election time three years ago, I shared my background, but for newer members of the community, I have now spent 34 years in the financial services business and lead a wealth management firm. Outside of my professional career, I served 12 years on the City of Montgomery Ohio's City Council including roles as the Chair of Zoning, Chair of Finance and Mayor. I currently serve on the Life Enriching Communities' Foundation Board, the Executive Committee of the Montgomery Chamber of Commerce and as board member on another HOA. In total, it represents a fair amount of practical experience in finance and project management, always with an eye toward operational excellence.



For the past three years I have enjoyed serving as an LLPOA Trustee. I have learned a lot more about the lake's operations, finances and most importantly, the opportunities this community is on the verge of realizing. I believe we should all be pleased in the tremendous progress being made to update our office and several successful improvements including two significant infrastructure projects (gates and bridge) - all while remaining fiscally responsible to our community.

The current Board has brought forth an important ask of the community with the Lakes Fund, and those involved with the Lakes Fund have proven to be a dedicated group that is driving incredible research and preparation for one of the largest projects the community has taken on. I welcome the opportunity to remain involved, assist in getting the current efforts across the finish line, and continue to strategically plan for the future. I would greatly appreciate your support. 🐾

# LEE'S TREES

Certified Arborist

Pruning and Removals

Certification: OH-5277A

(513) 382-4575

treeman780@gmail.com

# Lake Director Report

Chris Kwiatkowski

The LLPOA decals this year are **GOLD**. This was intentional and represents what I hope to be the golden age of Lake Lorelei. We have had an influx of new memberships this past year. Join me in welcoming them into this great community and showing them how special we really are.

As you may have already seen, we have some open positions within the Lake. If they are not already filled and you have experience and the skillsets described, then I encourage you to apply.

With the boating season fast approaching, I would encourage every member to get their LLPOA registration and decal requests completed ASAP to avoid any office backlogs. The membership dues, fees, and assessments are due March 1<sup>st</sup>. You will not be able to receive any LLPOA decals unless you are a member in good standing. **NEW:** Late charges will be applied to accounts this year per our governing documents. Payment plans can be made available to members, but you must contact the office to set them up.

You **MUST** have a **current LLPOA decal** on your boat to be on the water. Fines will be issued if your watercraft is on the water without the 2022 decal. Your lot number must also be displayed on each side of the watercraft with a 3-inch number. Members are also required to provide the office with their current ODNR registration and proof of insurance for watercraft.

We have performed under budget for January 2022, and will continue efforts to be cost conscious throughout the year. Our current compliance rate is 89.96% (as of 2/16/22). Our average completion time for permits for 2022 is 4.2 days.

I look forward to enjoying the summer with you all and continuing serving our community.

Let's have a fun and safe summer together! 🍷



## Boating Season is Here!

See Water Safety Reminders around the Lake, or visit [www.lakeloreleiohio.com](http://www.lakeloreleiohio.com) for complete regulations.

### Permits Issued in 2021

|                     |    |
|---------------------|----|
| Homes               | 4  |
| Home Additions      | 4  |
| Garages             | 9  |
| Fences              | 13 |
| Sheds               | 10 |
| Decks               | 12 |
| Docks               | 32 |
| Culverts/ Driveways | 10 |
| Other               | 26 |

### 2021 Lake Member Statistics

|                          |        |
|--------------------------|--------|
| Total Members            | 827    |
| Members in Good Standing | 731    |
| Payment Plans            | 13     |
| Members in Bad Standing  | 83     |
| Overall Compliance %     | 89.96% |
| Homes                    | 650    |

# JJ Lift Service, LLC.



Sales & Service for  
all Hewitt Lifts

Sales Rep for **Hewitt Boat Lifts**  
and Accessories

[www.hewitt-roll-a-dock.com](http://www.hewitt-roll-a-dock.com)

**Jimmy Johnson**

[jimmyjohnson@cinci.rr.com](mailto:jimmyjohnson@cinci.rr.com)

**513-875-3715**

# M & M Tree Service and Landscaping

**Free Estimates**  
**60 Ft. Bucket Truck**



## Services

- Tree Removal
- Stump Removal
- Dead Wooding
- Tree Cabling
- Pruning
- Landscaping
- Mulching
- Yard Clean up
- Bobcat Service

**513-432-5227**



[www.hudepohlheatandair.com](http://www.hudepohlheatandair.com)

**(937) 446-4200**

Email: [hudyhvac@gmail.com](mailto:hudyhvac@gmail.com)

24 Hour  
Emergency  
Service



State  
License  
# 31213

"A Professional is Not Satisfied Until You Are"

*Geothermal Specialist*

*Sales • Service • Equipment • Replacement*

### SERVICES

- Heating
- Venting
- Air Conditioning
- *Geothermal Specialist*
- Heat Pumps
- Oil
- Gas

### PARTS & ACCESSORIES

- Programmable Thermostats
- Humidifier
- High Efficiency Air Cleaners

*Commercial • Residential*

# Need a hand? Call *The Man!*



Carver Properties  
**Lawncare &**  
Property Maintenance

Doug Myers  
For help from the  
Handyman, call:

**(513)673-7831**

# Lake Life

Lee Duncan

## Let's Celebrate Arbor Day

Many people love trees, and there have been the earliest days of civilization. Arbor Day, with a strong Cincinnati connection.



been tree-planting festivals since the however, is strictly American in origin –

The first Arbor Day was celebrated in Nebraska. When settlers first arrived there, they missed the heavily treed landscape of their former homes in the east. They needed trees as windbreaks, to keep soil from eroding, wood for building and for fuel – not to mention shade on a hot summer day. A Nebraska newspaper editor named J. Sterling Morton had a great enthusiasm for planting trees and was first to propose the holiday, writing: “Other holidays repose upon the past; Arbor Day proposes for the future.” The first Arbor Day celebration was held on April 10th, 1872 and was a spectacular success with *over one million trees planted*.

What's the Cincinnati connection? The inaugural convention of the American Forestry Congress was held in Cincinnati in 1882, under the leadership of Cincinnati native John A. Warder. It was because of this convention and the AFC's promotion of the holiday that the tree-planting activities of Arbor Day started to become a popular annual event. On April 27th of that year, an estimated 25,000 people gathered in Eden Park to witness the planting of a white oak dedicated to George Washington. Subsequently, trees have been planted for each of the presidents who have served our country, and the grove is now spectacular; if you haven't been there, I highly recommend a visit. (By the way, oaks are particularly well suited as memorial trees due to their impressive presence and long lives.)

Arbor Day in Ohio is celebrated each year on the last Friday in April, which falls on April 29th this year. Each year, organizations such as **Cincinnati Parks** and **Keep Cincinnati Beautiful** have free or low-cost tree seedlings available. If you'd like a more established tree, it can be easy and inexpensive to hire a local landscape professional. (Of course, preferably one that advertises in the *Legend*). Trees add so much to our landscape and well-being, so this year, let's celebrate Arbor Day by planting a tree - it's bound to make you more **poplar!** 🌳

### References:

<https://www.arborday.org/celebrate/history.cfm>

<https://library.osu.edu/site/osulstaff/2017/04/28/arbor-day-weekend-great-time-to-visit-building-ohio-state-exhibit/>

<https://www.cincinnati.com/story/entertainment/2018/04/25/what-arbor-day-when-arbor-day/525286002/>

**Fayetteville  
Hardware & Supply, LLC**



TOOLS  
PARTS  
NEW & USED EQUIPMENT



19535 U.S. 68                      Tel. (513) 875-3030  
Fayetteville, Ohio 45118              Fax (513) 875-2371



**SIBCY  
CLINE**  
REALTORS®

**William Kidwell**  
Realtor®  
NAR  
OAR  
SOAR

OFFICE: (513) 248-0800  
VOICE: (513) 786-9568  
CELL: (513) 910-8947  
EMAIL: [wkidwell@sibcyclyne.com](mailto:wkidwell@sibcyclyne.com)



EQUAL HOUSING  
OPPORTUNITY

1077 State Route 28 • Suite 111 • Milford, Ohio 45150  
Web Site: <http://www.sibcyclyne.com>

**WITHAMSVILLE**  
**WINNELLSON**  
PLUMBING SUPPLY

**753-1121**

FAX: (513) 753-3130

- \* **WATER HEATERS**
- \* **FAUCETS AND FCT. PARTS**
- \* **TOILETS AND TOILET PARTS**
- \* **TUBS AND WHIRLPOOLS**
- \* **SHOWERS AND ENCLOSURES**
- \* **PIPES, VALVES AND FITTINGS**
- \* **DELIVERING TO LAKE LORELEI**

**MON-FRI 7:30-5:00**  
**SAT 9:00-1:00**

**622 Ohio Pike**  
**Withamsville, Ohio**

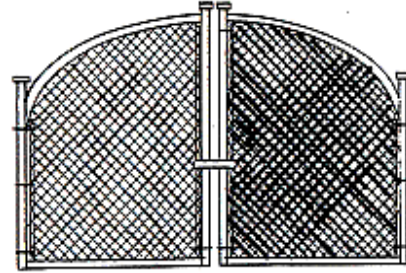

**COUCH'S FENCE COMPANY**

**INDUSTRIAL—RESIDENTIAL**  
**ALL TYPES OF WOOD & CHAIN**  
**LINK**

**TERRY COUCH**  
**(513) 625-7771**  
**(513) 625-0371 FAX**

**5414 ST. RT. 133**  
**WILLIAMSBURG**  
**OH 45126**

**YOU'VE MADE IT!**

How do you make sure  
that you keep it?

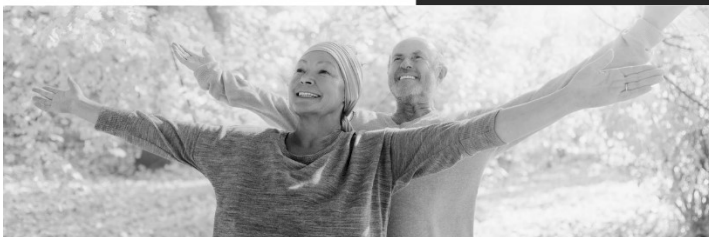

**PLAN YOUR RETIREMENT**

With a fee-only fiduciary advisor who is required to act in your best interest. For a no-obligation, introductory meeting, contact Dave Wilder, CFP®

**TOTAL WEALTH**  
**PLANNING**

Visit [twpteam.com](http://twpteam.com) for more information about our firm and additional financial planning and investment management services

513.984.6696 | [info@twpteam.com](mailto:info@twpteam.com)



*Serving The Tri State Area Since 1953*  
**(513) 791-2300 – [AlamoElectronics.com](http://AlamoElectronics.com)**

**FREE 3 year warranty**  
**on all 55" & larger TVs!**

- Sony 100" TV, Yes a 100" TV on display at Alamo Electronics
- Sonos Wireless Music Systems
- Smart Home Automation
- Home Audio music systems
- TV Mounting & Installation
- Knowledgeable Sales Staff
- Competitive Pricing

9572 Montgomery Road Cincinnati, OH 45242

# Lakeside Gardening



Gary Hetzell

## Early Spring Hints & Tips

As we approach Spring, there are a few veggies we all can plant early that tolerate frost and actually taste better in cooler temperatures. You can plant peas, broccoli, kale, arugula, cabbage, spinach, carrots, radishes, scallions and lettuce. You should buy your seeds and garden supplies and be ready to go when you can work the soil.

Walk around your garden looking for any perennials that might have heaved out of the ground over winter and tuck them back in with some extra soil around the root system.

Clear out leaves, any broken branches and matted foliage when inspecting your landscape early on. Now is a great time to cut back ornamental grasses before the new foliage growth starts.

Please don't get too antsy and plant warm weather crops like tomatoes & peppers early! The nighttime temperature should be above 50 degrees. Put your hand down into the soil; if it is too cold, the tomatoes and peppers will just sit in their planting holes and be stressed out. If you wait till that soil warms up, you will be rewarded with a faster growing, healthier plant.

I'm here for any questions you might have. PM me or stop by 602 Lorelei Drive anytime.

Happy 2022 Gardening !!









**All New 2022 20' Moomba Mondo**







**4811 Kellogg Avenue Cincinnati, OH 45226**  
**513-871-5555 www.searayofcincinnati.com**

**TLC**

**Construction & Design, LLC**  
Tim Carter, Owner

**New Construction  
Remodeling/Additions**

- Kitchen Cabinets
- Bathrooms
- Ceramic Tile
- Hardwood Flooring Installation



513-383-2941 (Cell)    [timctr7@aol.com](mailto:timctr7@aol.com)

**“Gravel Guy”**

**Trucking &  
Bobcat Service**



*Gravel, Soil, Sand, Mulch Delivered*  
Grading, Clean-up, Driveways, Heavy Use Pads,  
Drainage Problems Corrected

**513-519-4192**

Start your Spring Cleaning! It is time for  
the LL Women's Club

# 2022 SPRING COMMUNITY



Friday (members only), April 29 from 6 to 8 pm  
Saturday and Sunday, April 30 & May 1 from 9 am to 4 pm

## Permits Required!

- \* **\$10.00** - includes area advertising and a lake map for visitors.
- \* Pick up Registration forms in the Office, Gatehouse, Marina, or Restaurant
- \* Completed forms and payment due to the office **NO LATER** than **Tuesday, April 26th**

### *5% Lake Lorelei Discount!*

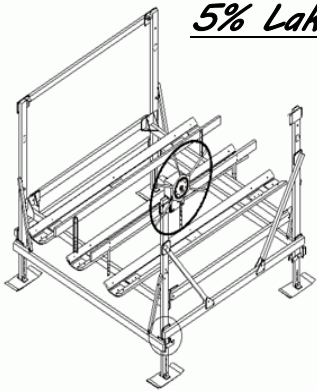

>LOWEST PRICES  
>HIGHEST QUALITY  
Ohio Boat Lift, LLC  
Dealer for Lakeside Lift Corp.  
Pete Zawaly, Lake Lorelei  
Call: 614-216-1798  
Email: [peter@ohioboatlift.com](mailto:peter@ohioboatlift.com)  
Visit: [www.lakesidelift.com](http://www.lakesidelift.com)

## D & M Services



Weekly, Bi-Weekly, Monthly  
Or One Time Service  
Thorough Cleaning Service  
FREE ESTIMATES!  
(513) 265-4223  
[dickymo4@cinci.rr.com](mailto:dickymo4@cinci.rr.com)

**Dick & Michele Hatton**  
Lake Residents

## Spring is Here!

*It's a great time to sell your home!  
If you are considering making a move,  
please call for a consultation.*



Jenny Fehr  
REALTOR®  
[Jennysellscincy@gmail.com](mailto:Jennysellscincy@gmail.com)

**513-314-1391**

**BASTION**  
REALTORS®  
*move.build.invest*



# Board of Trustees - Meeting Minutes

Thursday, December 16, 2021, 7:00 p.m.

**Trustees in Attendance:**

President: Rick Connors Rick Hosea  
 Vice President: Jimmy Johnson Bruce Simeone  
 Secretary: Denis Behm James Padgett  
 John Wyman  
 Kathryn Greene

**Trustees Absent:**

Treasurer: Todd Steinbrink

**Number of Members in Attendance: 13**

|   |   |
|---|---|
| <b>Call to Order</b>                          | Meeting was called to order at 7:00 PM  |
| Establish Quorum                              | Quorum was established.   |
| Pledge of Allegiance                          | Rick Connors led the pledge of allegiance.  |
| Moment of Silence                             | Moment of silence in remembrance all those members who have passed away.  |
| <b>Motions</b>                                |   |
| Minutes from last meeting                     | Motion made by Denis Behm to approve the minutes of last Board meeting that had been previously emailed to the board, 2nd by Jimmy Johnson approved by the 7 trustees in attendance.  |
| 2022 Budget                                   | Motion made by Denis Behm to approve the 2022 Budget presented by Chris Kwiatkowski, 2nd by Jimmy Johnson and approved by the 7 trustees in attendance. The budget is available in the office for members to review.  |
| Restaurant Freezer/ walk-in replacement       | Motion made by Rick Connors to approve the total cost of \$19,000.00 presented in a bid from Valley Refrigeration Service, Inc. for the replacement of the restaurant freezer, 2nd by Jimmy Johnson. After discussion by Rick Connors, Jimmy Johnson, & John Wyman about the age, past costs to maintain the present one, and the terms of the bid, the motion was approved by the 7 trustees in attendance voting. The bid is available in the office for members to review  |
| Crafts Club Charter- Pat Stirnkorb presenting | Patricia Stirnkorb presented the Board with a charter for a new Arts, Crafts & Hobby Club to be formed and asked for approval by the board. Question was raised about the need for an official checking account to be set up for them and she said there would be no dues and the only monies collected would be for each particular meeting and those would be paid directly to the presenter so that could be handled internally. Motion made by Denis Behm to approve the new club, 2nd by Jimmy Johnson and approved by the 7 trustees in attendance.   |
| Sheriff contract                              | The 2022 Brown County Sheriff's contract was presented by Chris Kwiatkowski who explained that the only change from the previous years was the .50 cent per hour increase. Rick C asked if we still could set the schedule and Chris explained that we could but had to remember that the duties were being performed as additional hours for them and it would depend on their scheduling for availability. Motion was made by Jimmy Johnson to accept and 2nd by Denis Behm and approved by the 8 trustees in attendance (K. Greene arrived). The contract is available in the office for review. |





Lawn, Garden, Farm & Motor Sports

664 W Main St., Blanchester, OH 45107

Phone: 937-783-8330

Monday-Friday; 9 am to 5 pm

Saturday; 9 am to 12 pm

Selling the area's largest selection of parts, accessories and equipment for:

- \*STIHL
- \*ARIENS/GRAVELY
- \*TORO
- \*SCAG
- \*DR POWER
- \*HUSQVARNA
- \*BRANSON
- \*VORTEXX
- \*GENERAC
- \*HAMMERHEAD
- GO-KARTS
- \*KAWASKI
- \*BRIGGS
- \*KOHLER
- \*HONDA
- \*TECUMSEH
- \*GRASSHOPPER
- \*TRAEGER
- \*BCS AMERICA

Parts & service available for most other makes & models of lawn & garden equipment

Financing Available / Pick up & Delivery Available

www.caplingersalesandservice.com

EMAIL: caplingersales@gmail.com

# The Bar is OPEN!!

Stop by for your favorite Beer, Wine or Cocktail



Pizza  
Flatbread  
Appetizers  
Burgers  
Hoagies  
& MORE



## Sandy's Beach Bar & Grill

at the Clubhouse

513-875-4992

## ZUGG & Sons Repair SVC. LLC

*car care center*

The Next Generation of Automotive Service  
*Specializing in Automotive Repair*

COMPUTERIZED DIAGNOSTIC EQUIPMENT

513-875-2565

4296 St. Rt. 131, Fayetteville

**Just 6 Minutes East of Lake Lorelei**

Hours: Monday-Friday 10:00-6:00

## WE ARE THE WILDLIFE CONTROL EXPERTS



varmintguard.com 877.571.7100



**First State Bank**

Built on Belief

19575 US Highway 68 | Fayetteville

937.393.9170



F

fsb4me.com

FDIC

|                                |  |
|--------------------------------|--|
| <p><b>Directors Report</b></p> | <p>Chris Kwiatkowski gave a detailed report including:</p> <ul style="list-style-type: none"> <li>- 2022 Budget</li> <li>- Financial Summary</li> <li>- New Website</li> <li>- Hardware Updates</li> <li>- Software Updates</li> <li>- MIGS/ MNGS</li> <li>- Permits</li> </ul> <p>He discussed ballot that was sent out and the benefit of raising the initiation fee by \$500, along with the importance of the electronic voting item on the ballot and how its passing reduces our current costs to mail ballots by \$795.82 for printing, materials and mailing (not including labor). He also reminded members that their ballots had to be postmarked by December 20<sup>th</sup> to be counted.</p> <p>Chris also wanted to give Special Thanks to Kevin Hollstegge and his company Vision One IT consultants for their donations and continued technical support to update the Lake Lorelei office.</p> <p>A complete report is available in the office.</p>  |
| <p><b>Trustee Reports</b></p>  |  |
| <p>Jimmy Johnson</p>           | <p>Jimmy commented on the maintenance department and the unexpected ice situation at the front entrance and said they would be better prepared the next time. He also added that all our employees do a great job and hope that all members would remember them and donate to the annual employees Christmas fund and thank them for all they do for our association throughout the year.</p>  |
| <p>James Padgett</p>           | <p>James gave an update on our infrastructure and stated that they would be replacing culverts this winter and are finalizing plans to pave roads for 2022, and that the budget includes these improvement projects. He added that the salt for roads has been delivered. Chris K said we are well prepared for the winter.</p>  |
| <p>Bruce Simeone</p>           | <p>Bruce gave a Lakes Committee Update and said the master plan is on track for 2022. Lake Fund Dredging subcommittee has been interviewing dredgers. Most have commitments for 2022. The Master Plan is built in draft form. It is not ready to be shared as it is still in the 'Concept and Feasibility' stage of project development, but we are on track and on plan and not giving up on 2022. We will share the completed plan as it is not secret. Sampling of areas is complete. We needed to confirm particle make up. Sizes vary with location (which lake and which cove) but averages are Clay: 21 - 35%, Sand: 27 - 67%, Silt: 13 - 39%.</p> <p>AquaDoc performed a water depth/silt depth survey of Fichtelberg, Grunewald and the North Inlet to update / quantify how much silt we have to plan locations for storage / dry out. They are contacting loan institutions for prequalification to allow us to plan the timing of the various phases of the project and incorporate that into the RFP. Some dredgers need to know the approximate timing before committing resources for site visits. We are investigating permit procedures in parallel with this work. Group is close to RFP (Request for Proposal) development. A detailed report from the Lakes fund is available.</p> |

## B&C Total Chimney Care

- ◆ Animal Removal
- ◆ Bird Screens & Caps
- ◆ Damper Repairs
- ◆ Fire Box Masonry Repairs
- ◆ Flashing and Roof Repairs
- ◆ Relining
- ◆ Waterproofing Bricks

### Dryer Vent Cleaning



**(937) 382-3794**  
**Cell: (937) 302-6131**  
*Colossians: 3:23*

Since  
1987

## Thunderbolt Services, LLC



Doug Schmees  
**513-827-1436**

Your full time lake resident who is here to help you get the most of your free time at the lake.



- Lots Mowed/Bush Hogged
- Residential and open lot mowing
  - Brush Removal
  - Weed Trimming
- *Retired mechanic to complete your boat/PWC repairs and cleaning*



Amann Brothers  
 Construction  
 Fayetteville, Ohio

**513-875-8033**  
**513-490-3675**  
 amannbros@gmail.com



Bobcat Work  
 Gravel Driveways  
 Fill Dirt  
 Top Soil  
 Sod & Seeding  
 Landscape  
 Fencing of any kind  
 Boat Docks  
 Rip Rap

Concrete Driveways  
 Sidewalks  
 Porches  
 Patios  
 Boat Ramps  
 Footers  
 Garage Floors  
 Basement Floors  
 Concrete Removal  
 Concrete Drilling  
 Concrete Sawing



Also Available:  
 Garage Kits  
 Pole Barn Kits  
 &  
 MORE

Block Retaining Wall  
 Brick Pavers

**Mark Amann**

*All About You*

## Hair Salon & Day Spa, LLC.

Tue-Wed 3-8pm ~ Thurs 9am-12, 3-8pm  
 Fri-Sat 9am-3pm

At the intersection of US-50 and SR-131  
 19426 Vera Cruz Road  
 Fayetteville, OH 45118

**513-875-3000**

*Full Service Salon*

*Our NEW Stylist*

*Lexi is here for you!*

**NO WAIT!!!**

Tell them you saw it in the  
**LEGEND**

**BUY LOCAL!**

Support the Legend's Advertisers

Continued from page 27

|  |  |
|--|--|
| Kathryn Greene                               | <p>Kathryn first apologized for being late as she had a previous engagement she had to attend. She then commented that the Neighborhood Watch Program is still a work in progress and there is a lot more to do. Chris Kwiatkowski further commented that the meeting with Lt. Moore went well. A possible option is potentially dividing Lake Lorelei into sectors but we need volunteers to apply.</p> <p>We will have an open meeting with the Sheriff Liaison and interested applicants.</p> <p>Date for meeting TBD.</p>  |
| <b>Committee Representative Updates</b>      |  |
| Pride Committee                              | <p>Bruce stated that Pride once again, is having a very busy year. Len Pohlar has been selected as the acting leader of Pride replacing Jon Riehle. He is doing an awesome job but they are still looking for an additional Director for Pride. Bruce urged members to step up and help this awesome group of people.</p> <p>He also commented that the New PRIDE shed has been installed, and area upgrades and painting completed but are also on going. Mailbox work continues and Len has taken over the building of them. Special thanks to Len (plus Activities) for installing the Christmas lights at the front entrance. Fans in Pavilion are planned for next year and Len said they will be having their B &amp; B weekend in the spring and encouraged all members to help out and enjoy a barbecue provided by Pride after the workday. Calendars will be sent out soon and any donation that you can give for the calendars would be greatly appreciated. All the money goes back into improvements for our beautiful community.</p> |
| Fish Committee                               | No report  |
| Women's Club                                 | No report  |
| Lake Committee (water quality and Shoreline) | <p>Mike Powell reiterated the silt composition that was discovered with the sampling and is happy that in the northern cove and the smaller lakes there is about 4' of water and 2' of silt (1/3 silt to 2/3 water) which when removed will get us to the 6' depth desired. It is also helpful that most of the silt is comprised of sand which can be recycled and better used around our lake.</p>   |
| Activities Club                              | <p>Michelle Hatton said that activities are having their Friday night get togethers on the 1<sup>st</sup> and 3<sup>rd</sup> Fridays. It is a BYOB until the restaurant gets its liquor license and invited all to attend. She also said there will be a New Year Eve party from 9-1 with tickets being \$10.</p>  |
| Roads Committee                              | James Padgett gave his report earlier in the meeting under Trustee reports.  |
| Fireworks Committee                          | No report  |
| <b>Guest Speakers:</b>                       | No guest speaker   |
| <b>Adjournment:</b>                          | Motion was made at 7:50 by Denis Behm to adjourn and 2 <sup>nd</sup> by Jimmy Johnson. Motion passed by all 8 trustees in attendance.  |
| <b>Open Forum Followed</b>                   |  |

# Lake Lorelei Property Association Financial Summary

## CASH MODIFIED BASIS

### INCOME & EXPENSE SUMMARY JAN 1, 2021- DEC 31, 2021

|                               |                   |
|-------------------------------|-------------------|
| Income                        |                   |
| Auto Decals                   | 62,095.21         |
| Boat Inspection/ Decals       | 46,055.00         |
| Building Permits              | 25,589.77         |
| Community functions/ Projects | 51,904.22         |
| Dock Rental                   | 16,145.00         |
| Dues & Services               | 387,478.07        |
| Initiation Fees               | 23,577.29         |
| Lake Maintenance Fund         | 109,513.80        |
| Mowing & Chipping Fees        | 14,915.00         |
| Road Assessment Income        | 173,262.55        |
| Rents and Misc                | 23,600.06         |
| Sale of Lots                  | 39,232.50         |
| <b>Total Income</b>           | <b>973,368.47</b> |
| Expenses                      |                   |
| Accounting                    | 7,342.92          |
| Community Events/ Projects    | 38,806.10         |
| Merchant Service Fees         | 7,854.15          |
| Computer & Internet           | 17,649.75         |
| Personnel Expense             | 218,203.16        |
| Repairs & Maintenance*        | 380,427.88        |
| Property Tax                  | 12,870.87         |
| Utilities                     | 40,428.91         |
| Legal Fees                    | 16,087.86         |
| General Lake Maintenance      | 19,254.47         |
| Security, Outside Services    | 8,968.00          |
| Insurance                     | 29,769.76         |
| Other Expenses (Combined)     | 41,548.89         |
| <b>Total Expense</b>          | <b>839,212.72</b> |
| <b>Other Income/ Expense</b>  | <b>5,136.50</b>   |
| <b>Net Income</b>             | <b>139,292.25</b> |

**Note:** Information is based of the most current data available.  
**Note:** Detailed reports are available in the Lake Lorelei Office.

\* 2021 Lakes Fund expenses are summarized in the Lakes Fund financial report.

### RESERVE ACCOUNTS DEC 31, 2021

|                                |                   |
|--------------------------------|-------------------|
| General Reserves (CD's)        | 214,034.40        |
| General Reserve (Money Market) | 102,877.74        |
| <b>Total</b>                   | <b>316,912.14</b> |

|   |                   |
|---|-------------------|
| <b>ROAD ACCOUNT JAN 1, 2021- DEC 31, 2021</b> |                   |
| Beginning Balance                             | 337,474.04        |
| Income  | 173,262.55        |
| <b>Subtotal</b>                               | <b>510,736.59</b> |
| Expenses                                      |                   |
| Roads/ Dam/ Spillway                          | 303,437.70        |
| <b>Total Expense</b>                          | <b>303,437.70</b> |
| <b>Ending Balance</b>                         | <b>207,298.89</b> |

|  |                   |
|--|-------------------|
| <b>LAKE MAINTENANCE SEPT 1, 2021- DEC 31, 2021</b> |                   |
| Beginning Balance                                  | -                 |
| Income   | 109,513.80        |
| <b>Subtotal</b>                                    | <b>109,513.80</b> |
| Expenses   | 4,742.66          |
| <b>Total Expense</b>                               | <b>4,742.66</b>   |
| <b>Ending Balance</b>                              | <b>104,771.14</b> |

## Welcome New Neighbors!

*\*Compiled from LL Office records in the last two months*



Kayla Adams and Dakota Parks  
 James Hawkins  
 Nicholas Platt & Alexandra Carson  
 Elizabeth Petzold  
 Brayden Ponchot  
 Meera Rastogi & Robert Fry  
 Daniel T Seiller  
 Courtney Jasman Tekuelve  
 John & Karen Westerkamp



Please like and Follow us at  
 "Lake Lorelei Property Owners Association"

LLPOA's only approved Facebook Page

**ATTENTION: Speeding Fines will be enforced by radar!**  
 Watch out for walkers, joggers, bikers & golf carts

**SPEED LIMIT 25**

### Promote your business to Lake Lorelei's members!

#### 2022 Advertising Rates

**Business Card (3-3/4" x 2-1/4") \$25**  
**1/4 Page (3-3/4" x 4-5/8") \$45**  
**1/2 Page (7-5/8" x 4-5/8") \$80**  
**Full Page (7-5/8" x 9-1/2") \$150**

Contact: Martha Wallace  
 Email: [thelegend@lakeloreleiohio.com](mailto:thelegend@lakeloreleiohio.com)  
 513-257-6230

### SAVE THIS NOTICE! It may save your life

- \* Pick up a map at the office and circle your location on the lake (with letters).
  - \* Determine the **SHORTEST** distance from Fayetteville to your house – through the **FRONT GATE** or the **BACK GATE**.
- When calling 911, instruct the operator to direct the Life Squad thru the **FRONT** or **BACK GATE**.

### Leash Your Dog!

Loose dogs within the lake are a Class II Violation, resulting in a \$200 fine.  
**And it is best for your PUP!**



## Community Contacts

| Office                            | Phone        | Office                            | Phone        |
|-----------------------------------|--------------|-----------------------------------|--------------|
| Brown County Animal Shelter       | 937-378-3457 | Fayetteville Police               | 513-875-3535 |
| Brown County Health Department    | 937-978-6892 | Fayetteville Public Library       | 513-274-2665 |
| Brown County Sheriff's Department | 937-378-4435 | Fayetteville Schools              | 513-875-2423 |
| Brown County Veteran's Service    | 937-378-3155 | Fayetteville-Perry Sewer District | 513-875-4600 |
| Bureau of Motor Vehicles          | 937-378-4779 | Post Office - Fayetteville        | 513-875-3740 |
| Duke - Power Outage               | 800-543-5599 | Rumpke Customer Service           | 800-828-8171 |
| Duke Energy Customer Service      | 800-544-6900 | Spectrum Customer Service         | 855-707-7328 |
| Fayetteville Fire Department      | 513-875-2202 | Western Water                     | 513-722-1682 |

**Lake Lorelei Board of Trustees**

Embracing the past ~ Managing the present ~ Focused on the future

|                       |                 | <b>Term</b> | <b>End</b> | <b>Phone</b> | <b>Email</b>                        |
|-----------------------|-----------------|-------------|------------|--------------|-------------------------------------|
| <b>President</b>      | Rick Connors    | 2023        |            | 952-250-9790 | rick.connors@lakeloreleiOhio.com    |
| <b>Vice-President</b> | Jimmy Johnson   | 2023        |            | 513-875-3715 | jimmy.johnson@lakeloreleiOhio.com   |
| <b>Treasurer</b>      | Todd Steinbrink | 2022        |            | 513-793-9217 | todd.steinbrink@lakeloreleiOhio.com |
| <b>Secretary</b>      | Denis Behm      | 2022        |            | 513-673-8422 | denis.behm@lakeloreleiOhio.com      |
| <b>Trustees:</b>      | Kathryn Greene  | 2024        |            | 513-460-4947 | kathryn.greene@lakeloreleiOhio.com  |
|                       | Rick Hosea      | 2023        |            | 513-875-8304 | rick.hosea@lakeloreleiOhio.com      |
|                       | James Padgett   | 2024        |            | 513-266-3949 | james.padgett@lakeloreleiOhio.com   |
|                       | Bruce Simeone   | 2024        |            | 513-518-0073 | bruce.simeone@lakeloreleiOhio.com   |
|                       | John Wyman      | 2022        |            | 513-827-0074 | john.wyman@lakeloreleiOhio.com      |

**Have Something to Say?**

The Legend wants to hear from you!



- \* Send a Letter to the Editor
- \* Write an article
- \* Report on family events (Community Corner)

Your suggestions and ideas are always welcome! We will do our best to publish all appropriate content.

*The Editor reserves the right to make minor copy-editing changes, per accepted standards for punctuation, spelling, capitalization and usage. The Editor may adapt any submitted copy to conform as needed with the current publication layout and design standards.*

**Email: TheLegend@lakeloreleiOhio.com**

**Disclaimer**

Any opinion expressed in The Legend reflects only the opinion of the author and not the LLPOA, the Board of Trustees, the staff of The Legend, or any other person.

Advertising in The Legend is not an endorsement of products or services. The Legend staff reserves the right to reject the submissions for publication.

**Mission Statement**

The Booster Club was organized in 1968 to provide information on official and social activities of interest. The Legend is not an arm of the Board of Trustees but an independent publication approved by the Board of Trustees and is committed to serving the members of the Lake Lorelei Property Owners Association.

The Legend is a private newsletter funded for Lake Lorelei through commercial advertisers.

For more information on Lake Lorelei, visit [www.lakeloreleiOhio.com](http://www.lakeloreleiOhio.com)

**Lake Lorelei Office**

Phone: 513-875-3435

Fax: 513-875-4244

**Fall/Winter Office Hours**

Monday through Friday: 9 AM - 5PM

*If assistance is needed outside these hours, please call the office and we will make every effort to accommodate our residents.*

**Lake Director:** Chris Kwiatkowski

director@lakeloreleiOhio.com

**Member Coordinator:** Sarah Cook

membercoordinator@lakeloreleiOhio.com

**Office Assistant:**

Megan Connors

LLPOA accepts



**2022 LLPOA Board Meeting Schedule**

| JAN     | FEB               | MAR     | APR            | MAY               | JUN                 | JUL     | AUG               | SEP     | OCT               | NOV               | DEC     |
|---------|-------------------|---------|----------------|-------------------|---------------------|---------|-------------------|---------|-------------------|-------------------|---------|
|         | Quarterly Meeting |         | Annual Meeting | Quarterly Meeting | Spring Town Meeting |         | Quarterly Meeting |         | Fall Town Meeting | Quarterly Meeting |         |
| No Meet | 17 FEB            | No Meet | 9 APR          | 19 MAY            | 11 JUN              | No Meet | 18 AUG            | No Meet | 8 OCT             | 17 NOV            | No Meet |

*The Legend of Lorelei*  
PO Box 363  
Fayetteville, Ohio 45118

PRESORT STD  
U.S. POSTAGE  
**PAID**  
CINCINNATI, OH  
PERMIT NO. 770

**Copy/ADV Deadline for the May/June 2022 Legend is  
April 20, 2022**

**Email: [TheLegend@lakeloreleiohio.com](mailto:TheLegend@lakeloreleiohio.com)**

**Saturday, May 14th is  
Lake Lorelei Day at John's Flowers  
9 am - 6 pm**

**Just off Rte. 68, one mile south of Fayetteville  
513-875-3400**

**A percent of the day's sales goes  
to the  
Lake Lorelei Women's Club**